









# Wooden Bridge

Item #CWR003

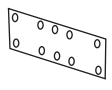
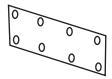
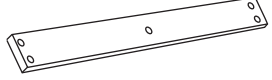
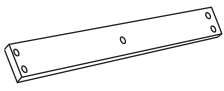
PART LIST			
No	Description	Figure	Qty
A	Side Post		4
B	Center Post		2
C	Railing		8
D	Arch		4
E	Center Arch		2
F	Arch Plate		4
G	Center Arch Plate		2
H	Long Boards		32
I	Short Boards		3
HARDWARE LIST			
J	Bolt (80mm long)		12
K	Bolt (40mm long)		24
L	Screws (30mm long)		175
M	Washer		12
N	Nut		36

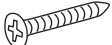

\*\*A drill with a screwdriver tip is not required, but it will make the assembly be much faster and easier.

**STEP 1**

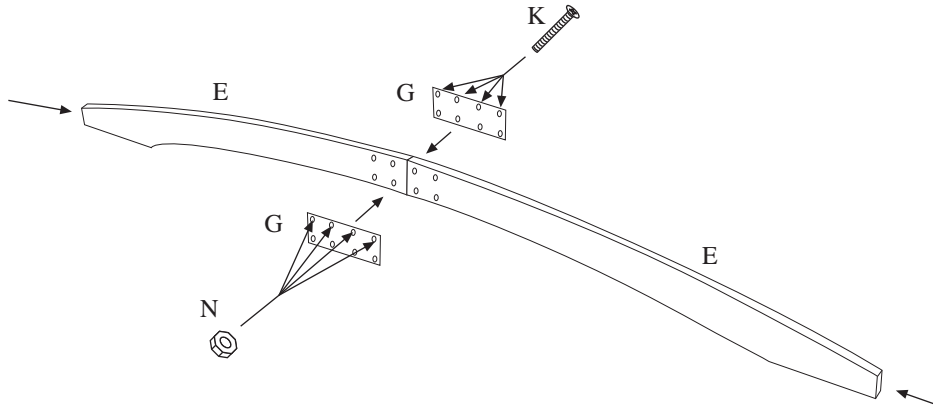

**STEP 2**

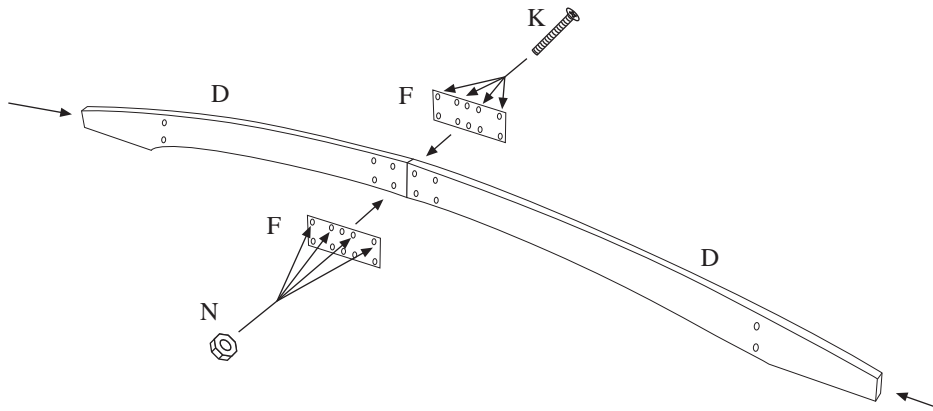

**STEP 3**

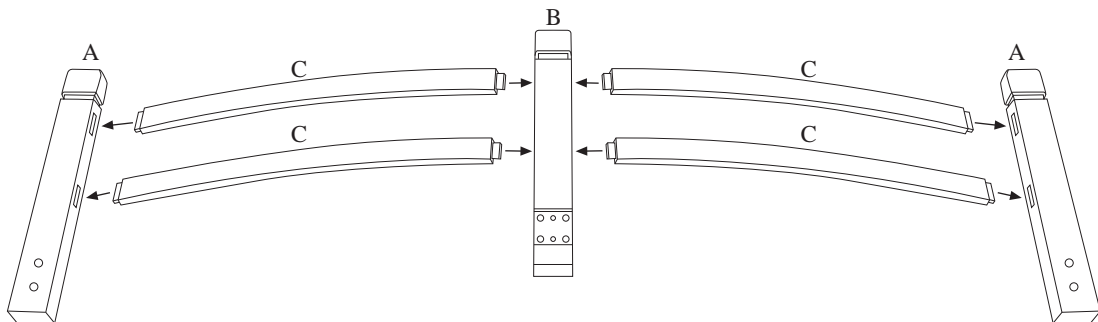

**STEP 4**

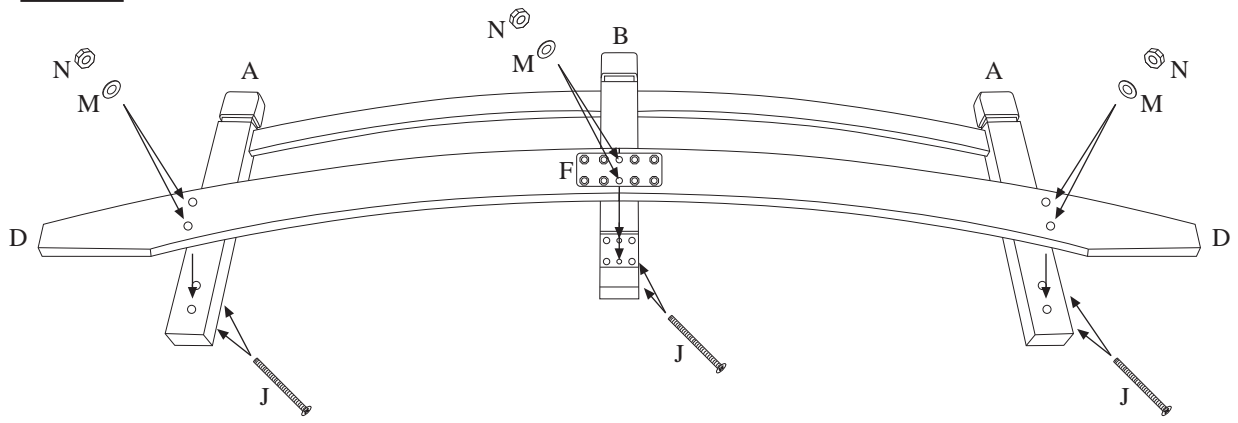

**STEP 5**

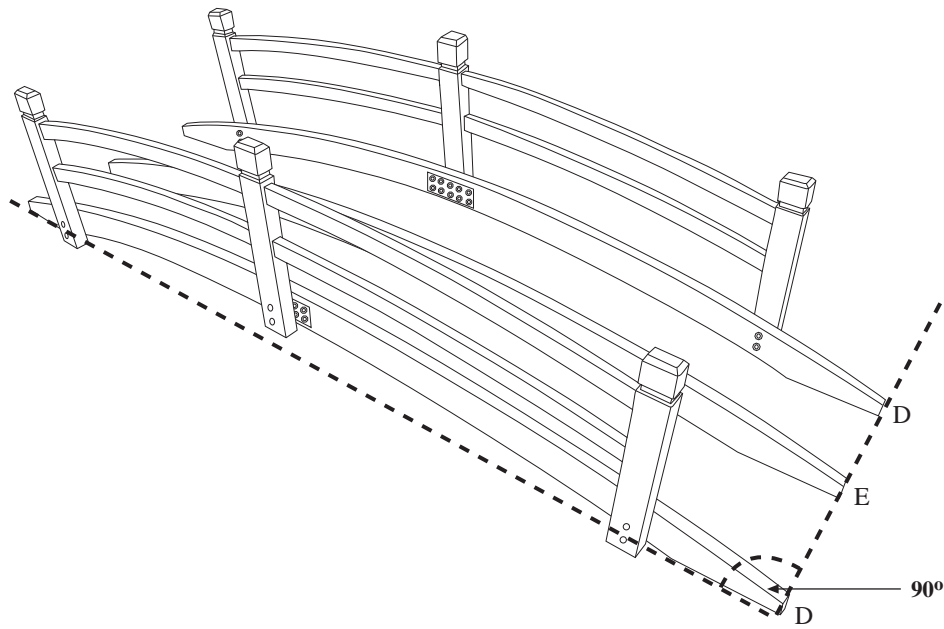

**STEP 6**

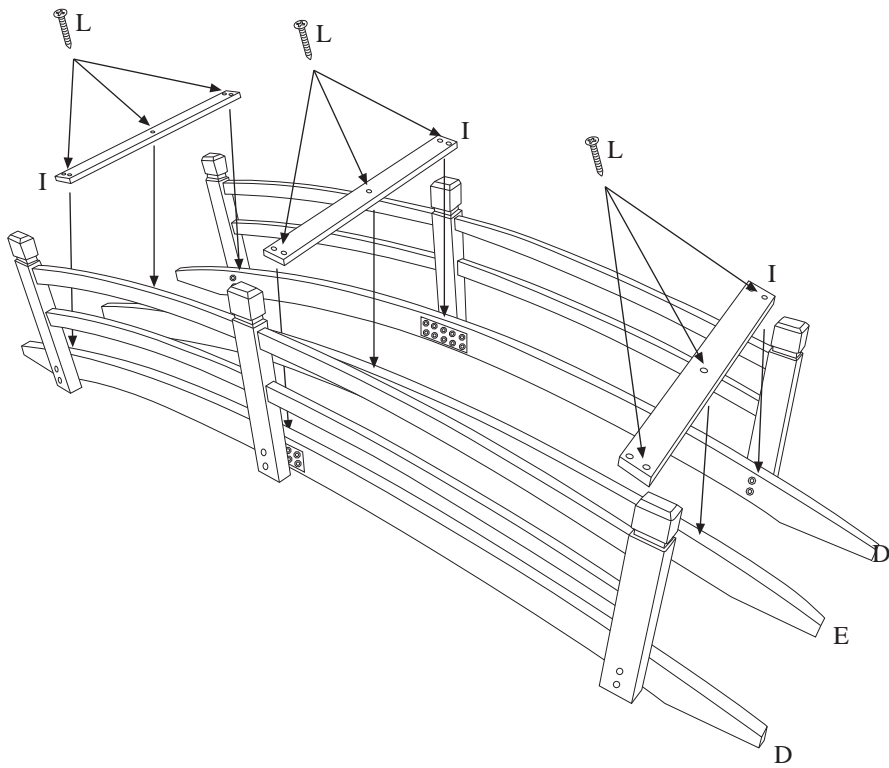

**STEP 7**

